

SPIDER 43 T













43T is diesel/lithium - Stability at high altitude.

- Automatic stabilisation and automatic storage device
- Bi energy Diesel + Lithium Ion batteries available on demand
- Radio remote control, with a selector fast/slow for the drive
- Easy maintenance
- Simple and intuitive on-board equipment
- Diagnostics with display installed on board
- Reduced overall dimensions
- Double telescopic articulated boom for an increased velocity while working at height



SPIDER 43 T

	43.18m		≥ 1.99m
	41.15m		8.46m
	17.33m		1.41m
	360°		17°
	2.34 x 0.87		≥ 12430kg
	330kg		

SPIDER 43 T

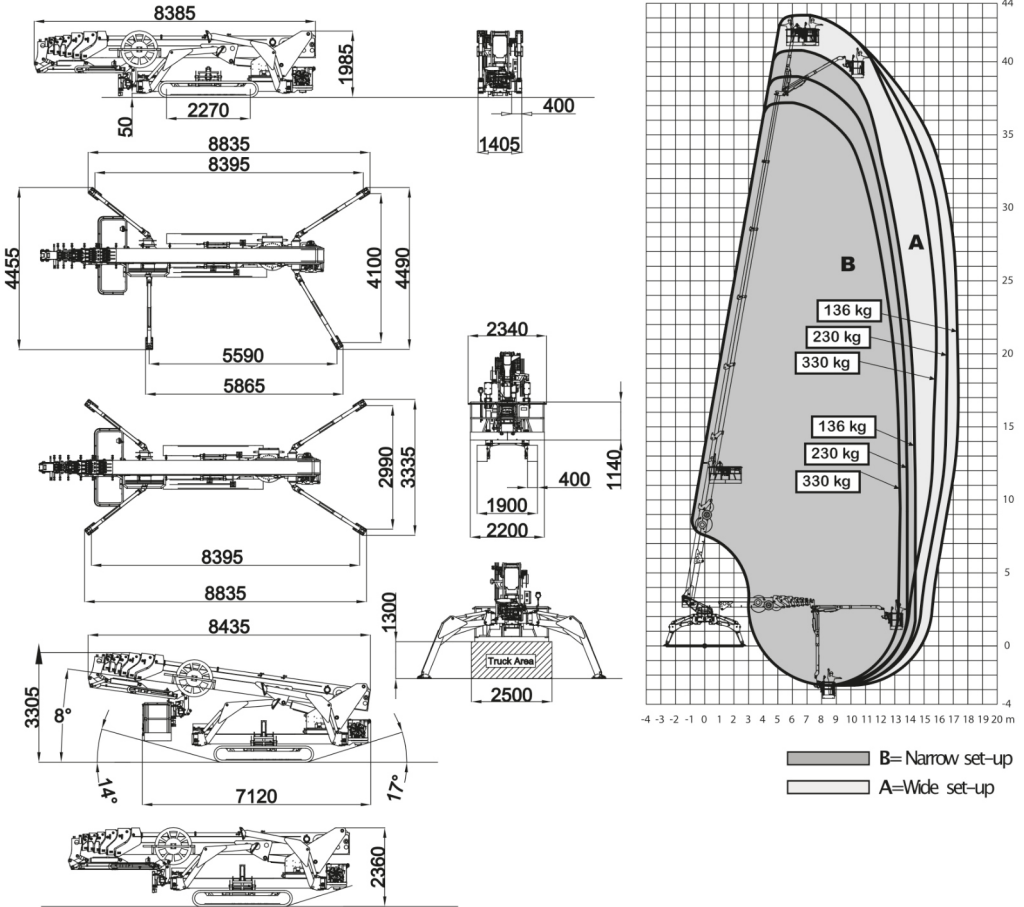

All measurements and weights are approximate and refer to the standard basic execution. *Outreach and height max values and repeatability can change within $\pm 3\%$ due to manufacturing variation and working condition.